

Dell™ 1420X/1430X Projector

User's Guide

Notes, Cautions, and Warnings



NOTE: A NOTE indicates important information that helps you make better use of your projector.



CAUTION: A CAUTION indicates either potential damage to hardware or loss of data and tells you how to avoid the problem.



WARNING: A WARNING indicates a potential for property damage, personal injury, or death.

Information in this document is subject to change without notice.

© 2011 Dell Inc. All rights reserved.

Reproduction of these materials in any manner whatsoever without the written permission of Dell Inc. is strictly forbidden.

Trademarks used in this text: *Dell* and the *DELL* logo are trademarks of Dell Inc.; *DLP* and *DLP* logo are trademarks of TEXAS INSTRUMENTS INCORPORATED; *Microsoft* and *Windows* are either trademarks or registered trademarks of Microsoft Corporation in the United States and/or other countries.

Other trademarks and trade names may be used in this document to refer to either the entities claiming the marks and names or their products. Dell Inc. disclaims any proprietary interest in trademarks and trade names other than its own.

Model 1420X/1430X

February 2012 Rev. A00

Contents

1	Your Dell Projector	6
	About Your Projector	7
2	Connecting Your Projector	9
	Connecting to a Computer	10
	Connecting a Computer Using a VGA Cable	10
	Monitor Loop-Through Connection Using VGA Cables	11
	Connecting a DVD Player	12
	Connecting a DVD Player Using an S-video Cable	12
	Connecting a DVD Player Using a Composite Video Cable	13
	Connecting a DVD Player Using a Component Video Cable	14
3	Using Your Projector	15
	Turning Your Projector On	15
	Turning Your Projector Off	15
	Adjusting the Projected Image	16
	Raising the Projector Height	16
	Lowering the Projector Height	16
	Adjusting the Projector Zoom and Focus	17

Adjusting Projection Image Size	18
Using the Control Panel	20
Using the Remote Control	22
Installing the Remote Control Batteries	24
Operating Range With Remote Control	25
Using the On-Screen Display	26
Input Source	26
Auto Adjust	27
Brightness/Contrast	28
Video Mode	28
Volume	29
Advanced Settings	29
Language	43
Help	43
4 Troubleshooting Your Projector	44
Guiding Signals	48
Changing the Lamp	49
5 Specifications	51
6 Contacting Dell	57
7 Appendix: Glossary	58

Your Dell Projector

Your projector comes with all the items shown below. Ensure that you have all the items, and contact Dell if anything is missing.

Package Contents

Power cable

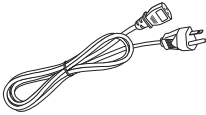

1.8 m VGA cable (VGA to VGA)

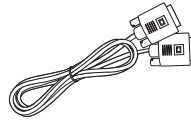

Remote control with battery



CD User's Guide & Documentation



Pull the tab before using the remote control

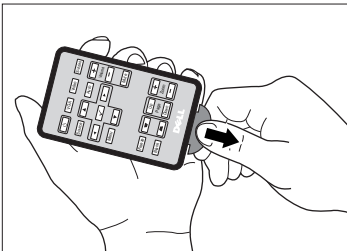

About Your Projector

Top View

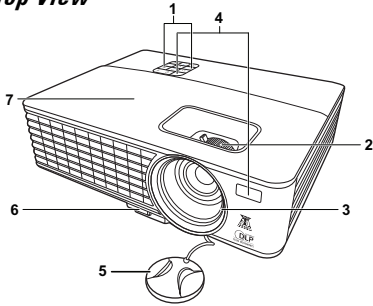

Bottom View

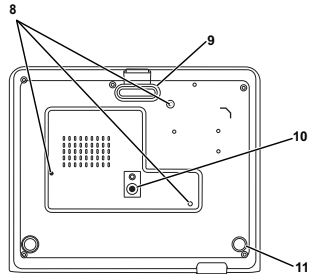

1	Control panel
2	Zoom tab and Focus ring
3	Lens
4	IR receivers
5	Lens cap
6	Quick-release button
7	Lamp cover
8	Mounting holes for ceiling mount: Screw hole M3 x 4.6mm depth. Recommended torque <8 kgf-cm
9	Front adjuster foot
10	Mounting hole for tripod: Insert nut 1/4"*20 UNC
11	Tilt adjustment wheel

WARNING: Safety Instructions

- 1 Do not use the projector near appliances that generate a lot of heat.
- 2 Do not use the projector in areas where there is an excessive amount of dust. The dust may cause the system to fail and the projector will automatically shutdown.
- 3 Ensure that the projector is mounted in a well-ventilated area.
- 4 Do not block the ventilation slots and openings on the projector.
- 5 Ensure the projector operates between ambient temperatures (0 °C to 35 °C).
- 6 Do not try to touch the ventilation outlet as it can become very hot after the projector has been turned on or immediately after it is turned off.

7 Do not look into the lens while the projector is on as it may cause injury to your eyes.

8 Do not place any objects near or in front of the projector or cover its lens while the projector is on as the heat may cause the object to melt or burn.



NOTE:

- Do not attempt to ceiling mount the projector yourself. It should be installed by a qualified technician.
- Recommended Projector Ceiling Mount Kit (P/N: C4504). For more information, see the Dell Support website at support.dell.com.
- For more information, see the *Safety Information* that shipped with your projector.

Connecting Your Projector

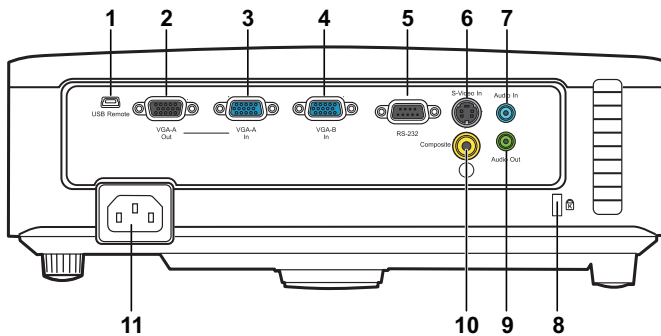

1	Mini USB (type B) remote connector	7	Audio input connector
2	VGA-A output (monitor loop-through)	8	Security cable slot
3	VGA-A input (D-sub) connector	9	Audio output connector
4	VGA-B input (D-sub) connector	10	Composite video connector
5	RS232 control port	11	Power cord connector
6	S-video connector		



WARNING: Before you begin any of the procedures in this section, follow the Safety Instructions as described on page 7.

Connecting to a Computer

Connecting a Computer Using a VGA Cable

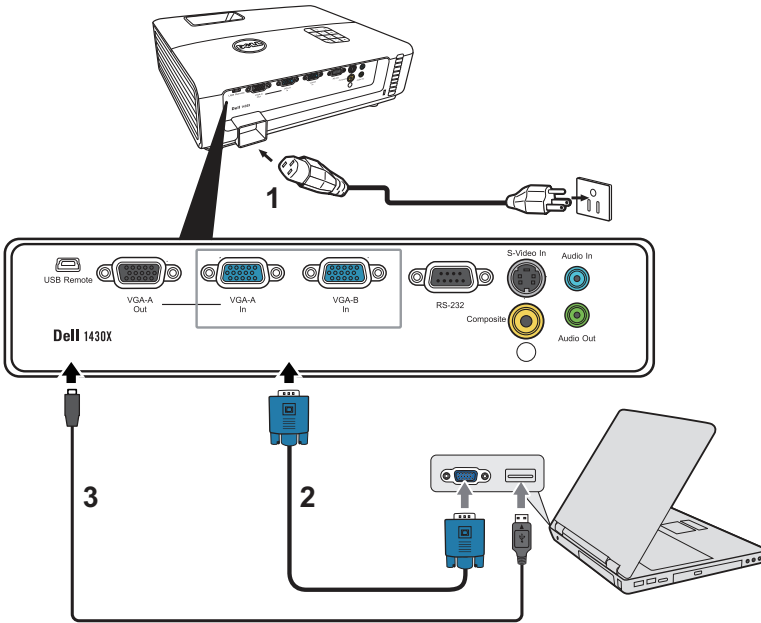

1	Power cord
2	VGA to VGA cable
3	USB-A to Mini USB-B cable



NOTE: The Mini USB-B cable is not provided with your projector.



NOTE: The Mini USB-B cable must be connected if you want to use the Page Up and Page Down features on the remote control.

Monitor Loop-Through Connection Using VGA Cables

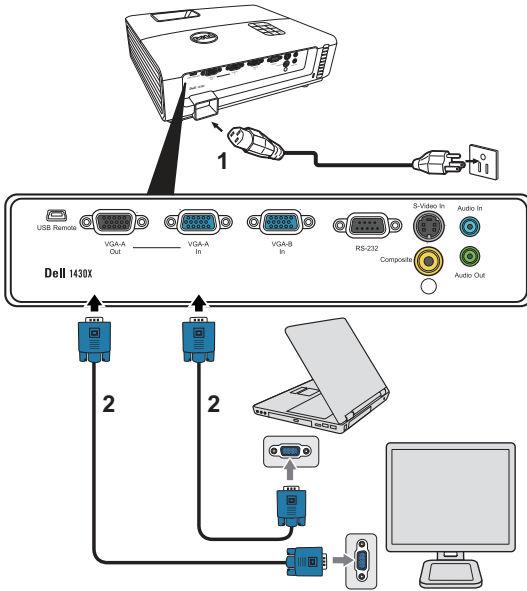

1	Power cord
2	VGA to VGA cable



NOTE: Only one VGA cable is shipped with your projector. An additional VGA cable can be purchased on the Dell website at www.dell.com.

Connecting a DVD Player

Connecting a DVD Player Using an S-video Cable

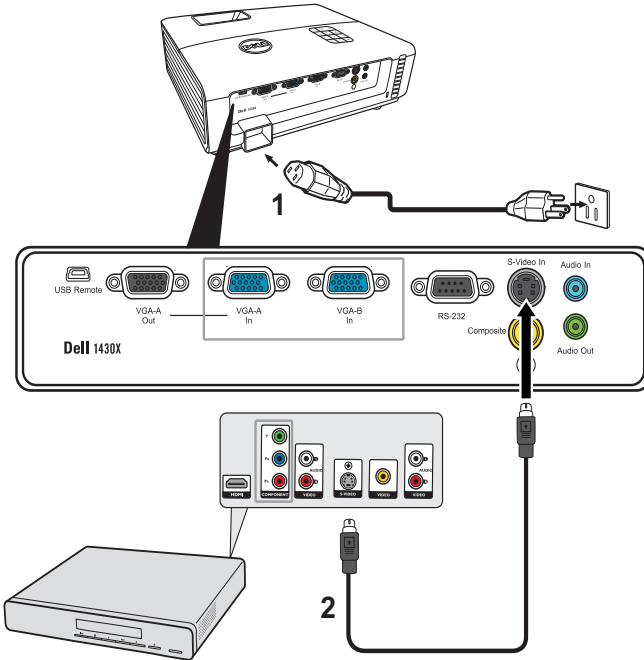

1	Power cord
2	S-video cable

NOTE: The S-video cable is not shipped with your projector. You can purchase the S-Video extension (50 ft/100 ft) cable on the Dell website at www.dell.com.

Connecting a DVD Player Using a Composite Video Cable

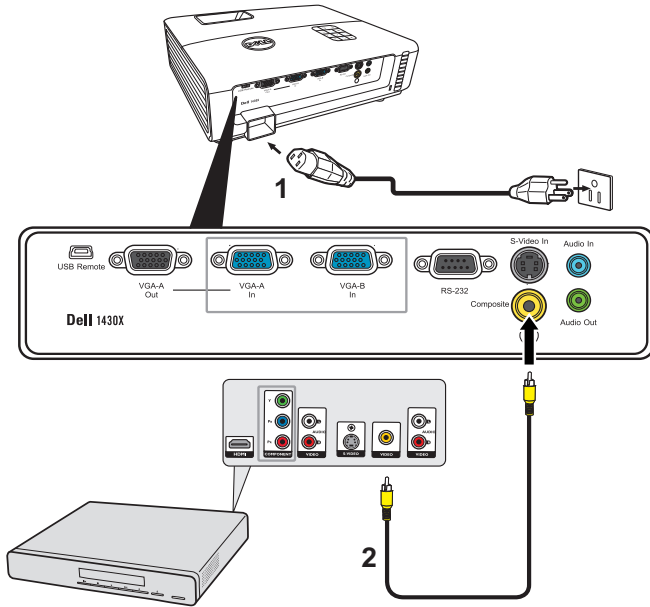

1	Power cord
2	Composite video cable



NOTE: The Composite Video cable is not shipped with your projector. You can purchase the Composite Video Extension (50 ft/100 ft) cable on the Dell website at www.dell.com.

Connecting a DVD Player Using a Component Video Cable

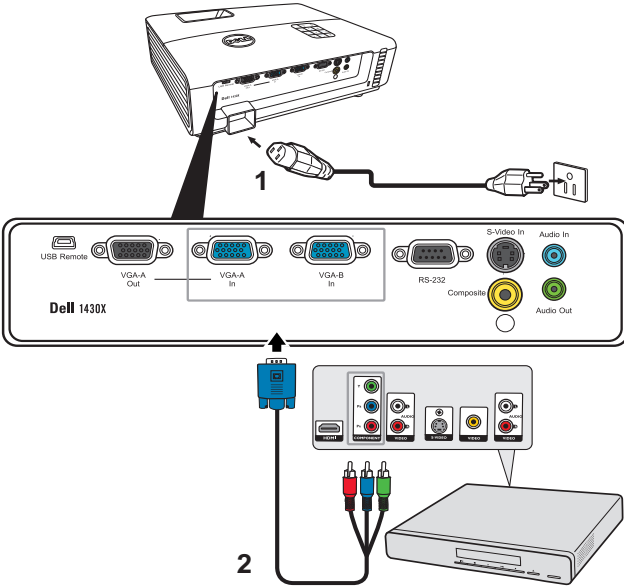

1	Power cord
2	VGA to Component Video cable

NOTE: The VGA to Component Video cable is not shipped with your projector. You can purchase the VGA to Component Video Extension (50 ft/100 ft) cable on the Dell website at www.dell.com.

Using Your Projector

Turning Your Projector On

 **NOTE:** Turn on the projector before you turn on the source (computer, DVD player, etc.). The **Power** button light blinks blue until pressed.

- 1 Remove the lens cap.
- 2 Connect the power cord and appropriate signal cables. For information about connecting the projector, see "Connecting Your Projector" on page 9.
- 3 Press the **Power** button (see "Using the Control Panel" on page 20 to locate the **Power** button).
- 4 Turn on your source (computer, DVD player, etc.)
- 5 Connect your source to the projector using the appropriate cable. See "Connecting Your Projector" on page 9 for instructions to connect your source to the projector.
- 6 By default, the input source of the projector is set to VGA-A. Change the input source of the projector if necessary.
- 7 If you have multiple sources connected to the projector, press the **Source** button on the remote control or control panel to select the desired source. See "Using the Control Panel" on page 20 and "Using the Remote Control" on page 22 to locate the **Source** button.

Turning Your Projector Off

 **CAUTION:** Unplug the projector after properly shutting down as explained in the following procedure.

- 1 Press the **Power** button.

 **NOTE:** The "**Press Power Button to Turn off Projector**" message will appear on the screen. The message disappears after 5 seconds or you can press the **Menu** button to clear it.

- 2 Press the **Power** button again. The cooling fans continue to operate for 60 seconds.

3 To power off the projector quickly, press the Power button and hold for 1 second while the projector's cooling fans are still running.

 **NOTE:** Before you turn on the projector again, wait for 60 seconds to allow the internal temperature to stabilize.

4 Disconnect the power cord from the electrical outlet and the projector.

Adjusting the Projected Image

Raising the Projector Height

- 1 Raise the projector to the desired display angle and press the quick-release button.
- 2 Use the tilt adjustment wheel to fine-tune the display angle.

Lowering the Projector Height

- 1 Hold up the projector while pressing the quick-release button, then slowly lower the projector and use the tilt adjustment wheel to fine-tune the display angle.

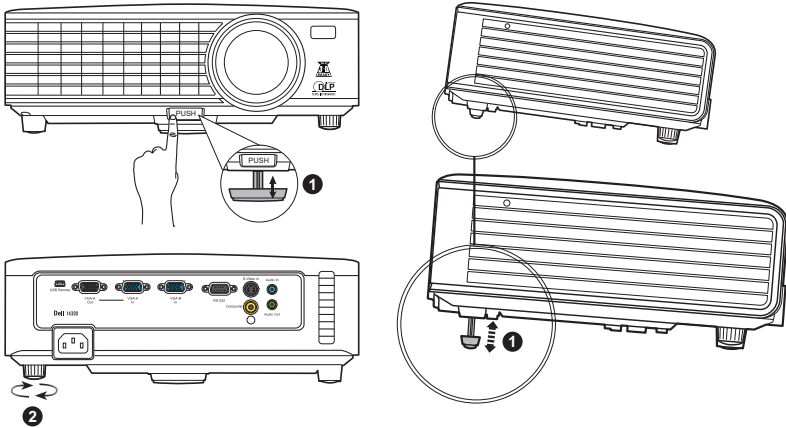

1	Front adjuster foot (Angle of tilt: 0 to 6 degrees)
2	Tilt adjustment wheel

Adjusting the Projector Zoom and Focus

⚠ WARNING: To avoid damaging the projector, ensure that the zoom lens and elevator foot are fully retracted before moving the projector or placing the projector in its carrying case.

- 1 Rotate the zoom tab to zoom in and out.
- 2 Rotate the focus ring until the image is clear. The projector focuses at distances ranging between 3.28 ft to 26.24 ft (1 m to 8 m).

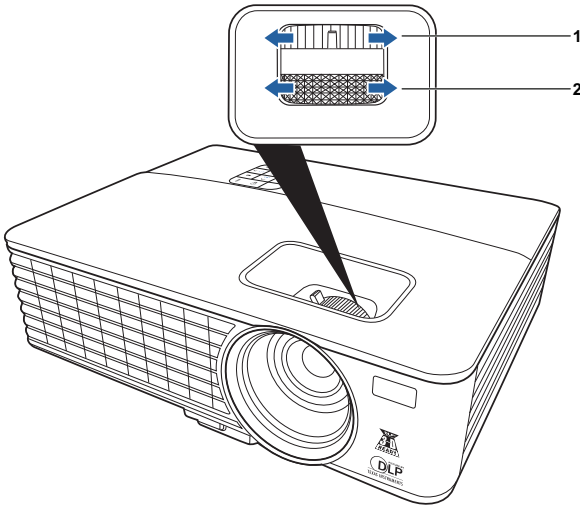

1	Zoom tab
2	Focus ring

Adjusting Projection Image Size

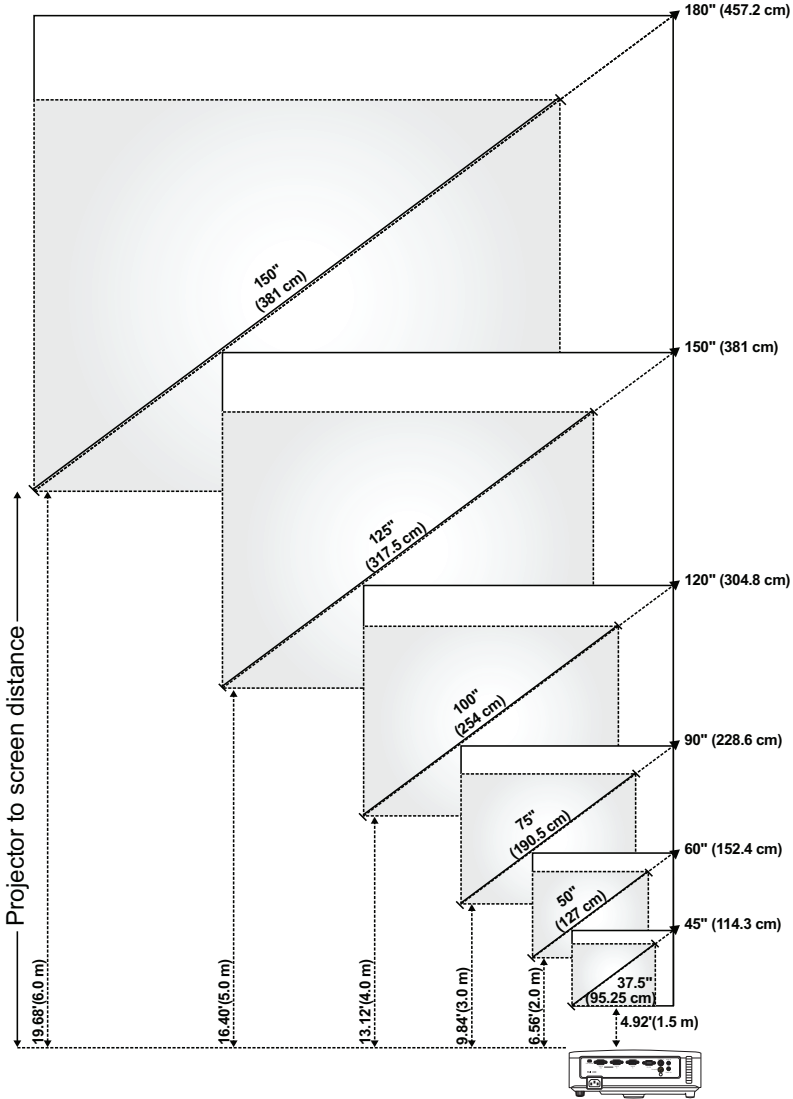





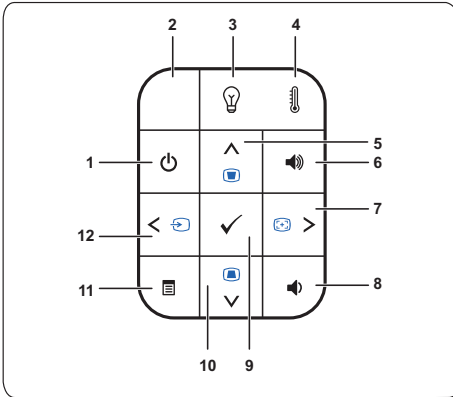



Screen (Diagonal)	Max.	45" (114.3 cm)	60" (152.4 cm)	90" (228.6 cm)	120" (304.8 cm)	150" (381 cm)	180" (457.2 cm)
	Min.	37.5" (95.25 cm)	50" (127 cm)	75" (190.5 cm)	100" (254 cm)	125" (317.5 cm)	150" (381 cm)
Screen Size	Max. (WxH)	36" X 27"	48" X 36"	72" X 54"	96" X 72"	120" X 90"	144" X 108"
		(91.44 cm X 68.58 cm)	(121.92 cm X 91.44 cm)	(182.88 cm X 137.16 cm)	(243.84 cm X 182.88 cm)	(304.8 cm X 228.6 cm)	(365.76 cm X 274.32 cm)
	Min. (WxH)	30" X 22.5"	40" X 30"	60" X 45"	80" X 60"	100" X 75"	120" X 90"
		(76.2 cm X 57.15cm)	(101.6cm X 76.2cm)	(152.4 cm X 114.3 cm)	(203.2 cm X 152.2 cm)	(254 cm X 190.5 cm)	(304.8 cm X 228.6 cm)
Hd	Max.	29.7" (75.44 cm)	39.6" (100.58 cm)	59.4" (150.88 cm)	79" (201.17 cm)	99" (251.46 cm)	118.8" (301.75 cm)
	Min.	24.75" (62.87 cm)	33" (83.82 cm)	49.5" (125.73 cm)	66" (167.64 cm)	82.5" (209.55 cm)	99" (251.46 cm)
Distance		4.92' (1.5 m)	6.56' (2.0 m)	9.84' (3.0 m)	13.12' (4.0 m)	16.40' (5.0 m)	19.68' (6.0 m)
* This graph is for user reference only.							

Using the Control Panel









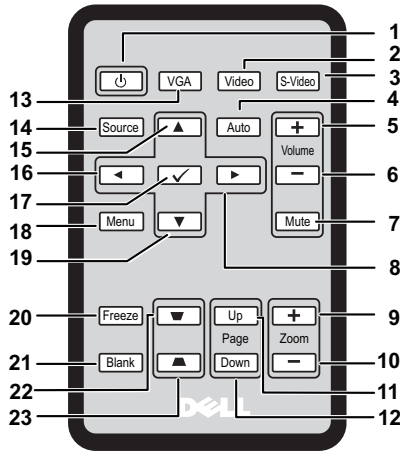







1 Power	Turns the projector on or off. For more information, see "Turning Your Projector On" on page 15 and "Turning Your Projector Off" on page 15.
2 IR Receiver	Point the remote control towards the IR receiver and press a button.
3 LAMP warning light	<p>If the LAMP amber indicator is on or blinking, one of the following problems could be occurring:</p> <ul style="list-style-type: none"> • Lamp is reaching its end of usable life • Lamp module is not properly installed • Lamp driver failure • Color wheel failure <p>For more information, see "Troubleshooting Your Projector" on page 44 and "Guiding Signals" on page 48.</p>

4	TEMP warning light	<p>If the TEMP amber indicator is on or blinking, one of the following problems could be occurring:</p> <ul style="list-style-type: none"> • Internal temperature of the projector is too high • Color wheel failure <p>For more information, see "Troubleshooting Your Projector" on page 44 and "Guiding Signals" on page 48.</p>
5	Up  / Keystone adjustment	<p>Press to navigate through the On-Screen Display (OSD) Menu items.</p> <p>Press to adjust image distortion caused by tilting the projector (+40/-40 degrees).</p>
6	Volume up 	Press to increase the volume.
7	Right  / Auto Adjust	<p>Press to navigate through the On-Screen Display (OSD) Menu items.</p> <p>Press to synchronize the projector to the input source.</p> <p> NOTE: Auto Adjust does not operate if the on-screen display (OSD) is displayed.</p>
8	Volume down 	Press to decrease the volume.
9	Enter 	Press to confirm the selection item.
10	Down  / Keystone adjustment	<p>Press to navigate through the On-Screen Display (OSD) Menu items.</p> <p>Press to adjust image distortion caused by tilting the projector (+40/-40 degrees).</p>
11	Menu 	Press to activate the OSD. Use the directional keys and the Menu button to navigate through the OSD.
12	Left  / Source	<p>Press to navigate through the On-Screen Display (OSD) Menu items.</p> <p>Press to toggle through Analog RGB, Composite, Component (YPbPr via VGA), and S-video sources when multiple sources are connected to the projector.</p>

Using the Remote Control



1	Power 	Turns the projector on or off. For more information, see "Turning Your Projector On" on page 15 and "Turning Your Projector Off" on page 15.
2	Video	Press to choose Composite Video source.
3	S-Video	Press to choose S-Video source.
4	Auto adjust	Press to synchronize the projector with the input source. Auto adjust does not operate if the OSD is displayed.
5	Volume up 	Press to increase the volume.
6	Volume down 	Press to decrease the volume.
7	Mute	Press to mute or un-mute the projector speaker.
8	Right 	Press to navigate through the On-Screen Display (OSD) Menu items.
9	Zoom +	Press to increase the image.
10	Zoom -	Press to decrease the image.

11	Page up 	Press to move to previous page.  NOTE: The Mini USB-B cable must be connected if you want to use the Page Up feature.
12	Page down 	Press to move to next page.  NOTE: The Mini USB-B cable must be connected if you want to use the Page Down feature.
13	VGA	Press to choose VGA source.
14	Source	Press to switch between Analog RGB, Composite, Component (YPbPr, via VGA), and S-video sources.
15	Up 	Press to navigate through the On-Screen Display (OSD) Menu items.
16	Left 	Press to navigate through the On-Screen Display (OSD) Menu items.
17	Enter 	Press to confirm the selection.
18	Menu	Press to activate the OSD.
19	Down 	Press to navigate through the On-Screen Display (OSD) Menu items.
20	Freeze	Press to pause the screen image.
21	Blank	Press to hide/show the image.
22	Keystone adjustment 	Press to adjust image distortion caused by tilting the projector (+40/-40 degrees).
23	Keystone adjustment 	Press to adjust image distortion caused by tilting the projector (+40/-40 degrees).

Installing the Remote Control Batteries

 **NOTE:** Remove the batteries from the remote control when not in use.

1 Push and hold the locking arm while pulling out the battery holder.

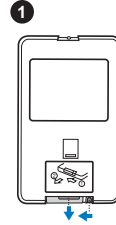

2 Check the polarity (+/-) marking on the battery.

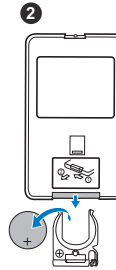

3 Insert the battery and align their polarity correctly according to the marking in the battery compartment.

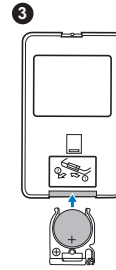

4 Push the battery holder back.

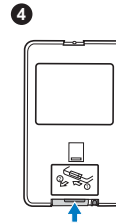



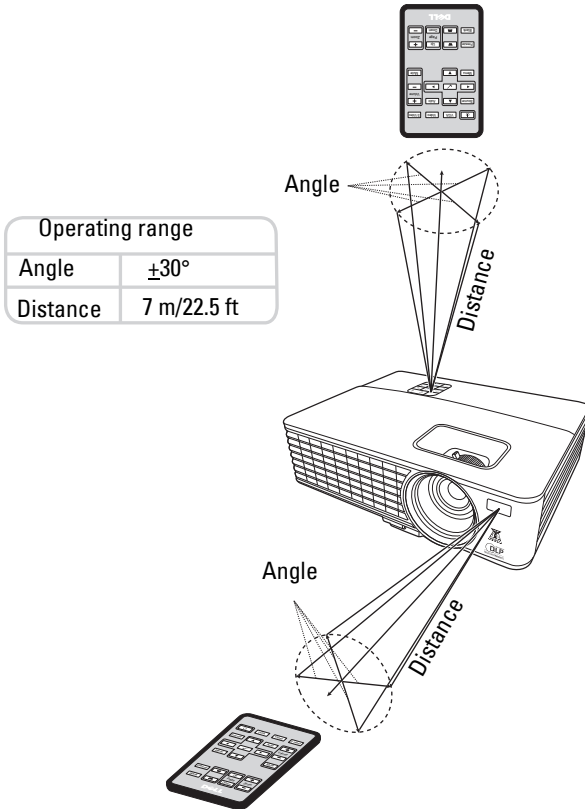





Operating Range With Remote Control



NOTE: Actual operating range may slightly differ from the diagram. Weak battery will also prevent the remote control from properly operating the projector.

Using the On-Screen Display

- The projector has a multi-language On-Screen Display (OSD) Menu that can be displayed with or without an input source.
- To navigate through the tabs in the Main Menu, press the  or  buttons on your projector's control panel or remote control.
- To select a submenu, press the  button on your projector's control panel or remote control.
- To select an option, press the  or  buttons on your projector's control panel or remote control. The color changes to dark blue. When an item is selected, the color changes to dark blue.
- Use the  or  buttons on the control panel or remote control to adjust the settings.
- To go back to the Main Menu, press the  button on the control panel or the remote control.
- To exit the OSD, press the  button or press the **Menu** button directly on the control panel or the remote control.

NOTE: OSD structure and set are the same for the 1420X and 1430X models.

Input Source

The Input Source menu allows you to select your projector's input source.

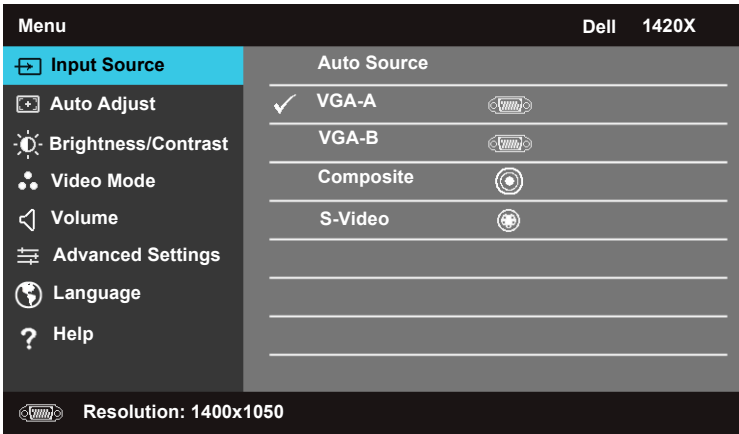



AUTO SOURCE—Select **Off** (the default) to lock the current input signal. If you press the **Source** button when the **Auto Source** mode is set to **Off**, you can manually select the input signal. Select **On** to auto detect the available input signals. If you

press the **Source** button when the projector is on, it automatically finds the next available input signal.

VGA-A—Press  to detect VGA-A signal.

VGA-B—Press  to detect VGA-B signal.

COMPOSITE—Press  to detect Composite Video signal.

S-VIDEO—Press  to detect S-Video signal.

Auto Adjust

Auto Adjust automatically adjusts the projector's **Frequency** and **Tracking** in PC mode.

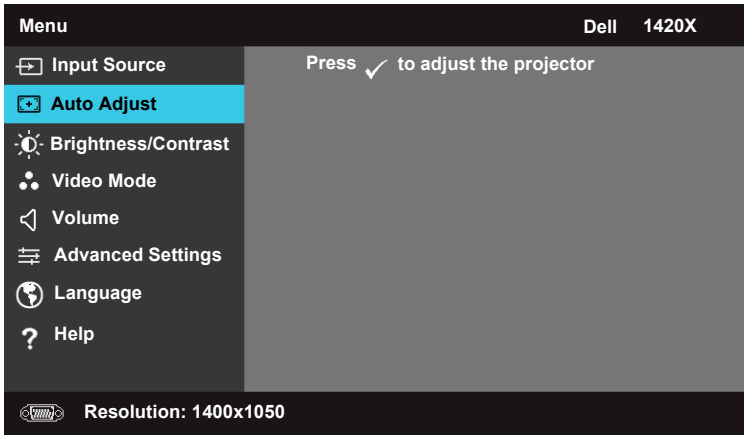

Brightness/Contrast

The Brightness/Contrast menu allows you to adjust the brightness/contrast settings of your projector.

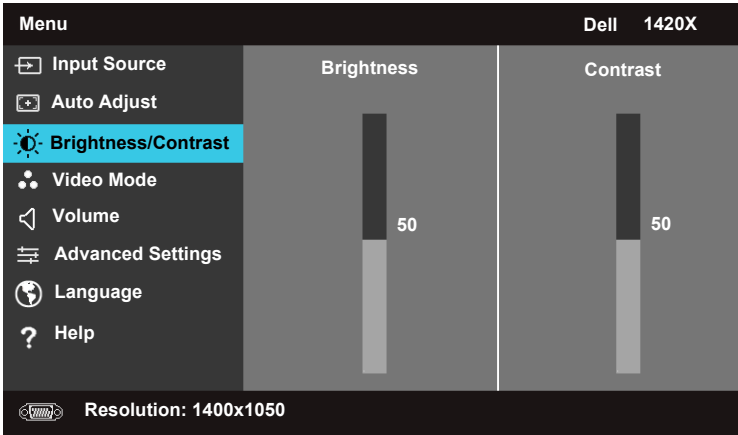

BRIGHTNESS—Use and to adjust the brightness of the image.

CONTRAST—Use and to adjust the display contrast.

Video Mode

The Video Mode menu allows you to optimize the display image: **Presentation**, **Bright**, **Movie**, **sRGB** (provides more accurate color representation), and **Custom**

(set your preferred settings).

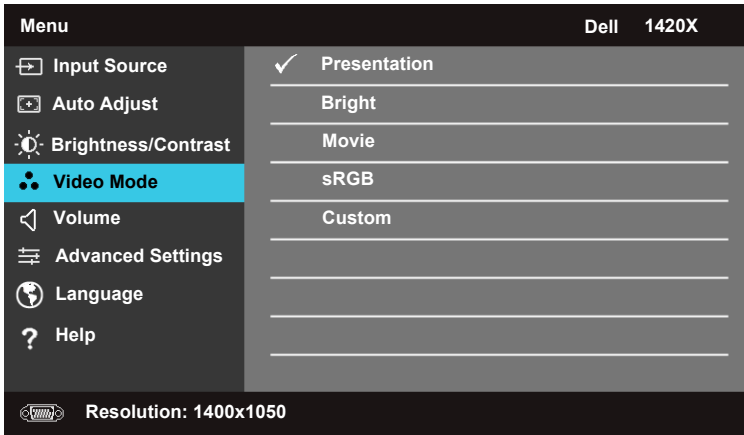

Volume

The Volume menu allows you to adjust the volume settings of your projector.

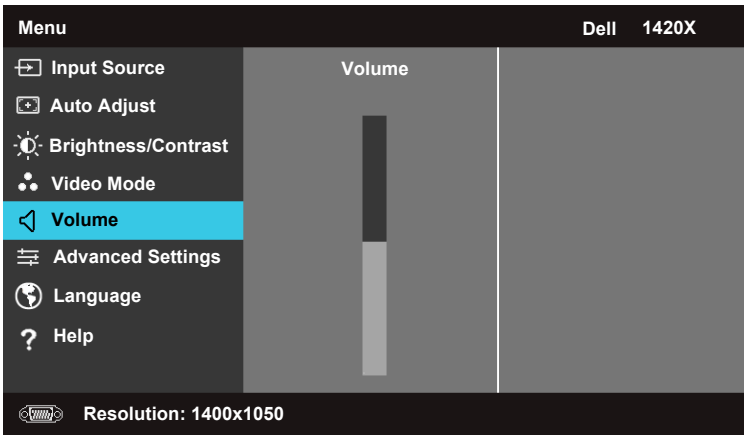

VOLUME—Press to increase the volume and to decrease the volume.

Advanced Settings

The Advanced Settings menu allows you to change settings for **Image**, **Display**,

Projector, Menu, Power, and Information.

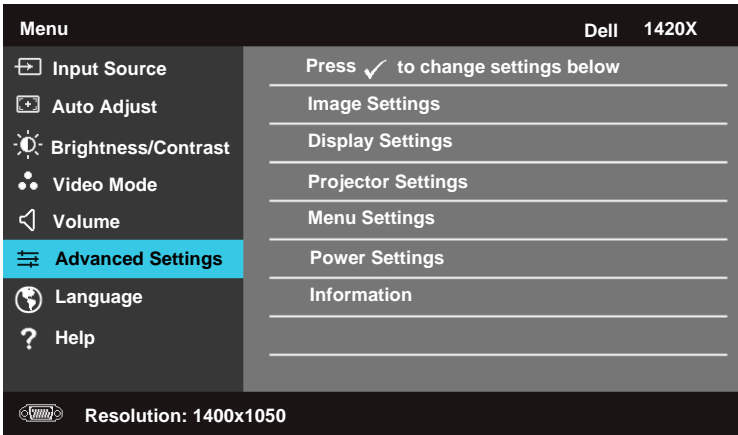
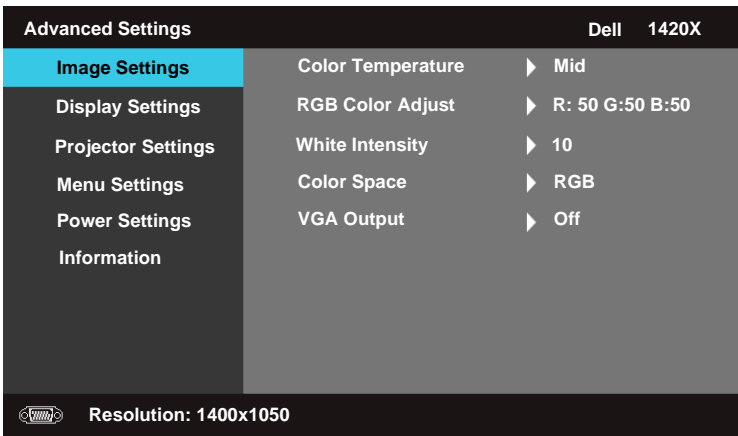

Image Settings (In PC Mode)

Select and press to activate image settings. The image settings menu provides the following options:



COLOR TEMPERATURE—Allows you to adjust the color temperature. The screen appears cooler at higher color temperatures and warmer at lower color temperatures. When you adjust the values in the **RGB Color Adjust** menu, the Custom mode is activated. The values are saved in the Custom mode.

RGB COLOR ADJUST—Allows you to manually adjust the colors red, green, and blue.

WHITE INTENSITY—Use and to adjust the display white intensity.

COLOR SPACE—Allows you to select the color space, options are: RGB, YCbCr, and YPbPr.

VGA OUTPUT—Select **On** or **Off** to enable or disable the VGA output function at projector standby status. Default is **Off**.



NOTE: If you adjust the settings for **Color Temperature**, **RGB Color Adjust** and **White Intensity**, the projector automatically switches to **Custom**.

Image Settings (In Video Mode)

Select and press to activate image settings. The image settings menu provides the following options:

Advanced Settings		Dell 1420X
Image Settings	Color Temperature	▶ Mid
Display Settings	RGB Color Adjust	▶ R: 50 G:50 B:50
Projector Settings	Saturation	▶ 50
Menu Settings	Sharpness	▶ 16
Power Settings	Tint	▶ 50
Information	White Intensity	▶ 10
	Color Space	▶ YCbCr
	VGA Output	▶ Off

Resolution: 720x480

COLOR TEMPERATURE—Allows you to adjust the color temperature. The screen appears cooler at higher color temperatures and warmer at lower color temperatures. When you adjust the values in the **RGB Color Adjust** menu, the Custom mode is activated. The values are saved in the Custom mode.

RGB COLOR ADJUST—Allows you to manually adjust the colors red, green, and blue.

SATURATION—Allows you to adjust the video source from black and white to fully saturated color. Press to decrease the amount of color in the image and to increase the amount of color in the image.

SHARPNESS—Press to decrease the sharpness and to increase the sharpness.

TINT—Press to decrease the amount of green in the image and to increase the amount of red in the image (available for NTSC only).

WHITE INTENSITY—Use and to adjust the display white intensity.

COLOR SPACE—Allows you to select the color space, options are: RGB, YCbCr, and YPbPr.

VGA OUTPUT—Select **On** or **Off** to enable or disable the VGA output function at projector standby status. Default is **Off**.

 **NOTE:** If you adjust the settings for **Color Temperature, RGB Color Adjust, Saturation, Sharpness, Tint** and **White Intensity**, the projector automatically switches to **Custom**.

Image Settings (No Input Source)

Select and press to activate image settings. The image settings menu provides the following options:

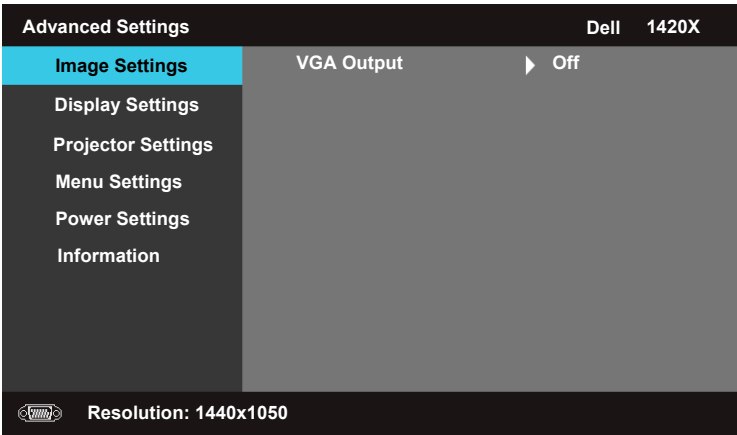

VGA OUTPUT—Select **On** or **Off** to enable or disable the VGA output function at projector standby status. Default is **Off**.

Display Settings (In PC Mode)

Select and press to activate Display settings. The Display settings menu provides the following options:

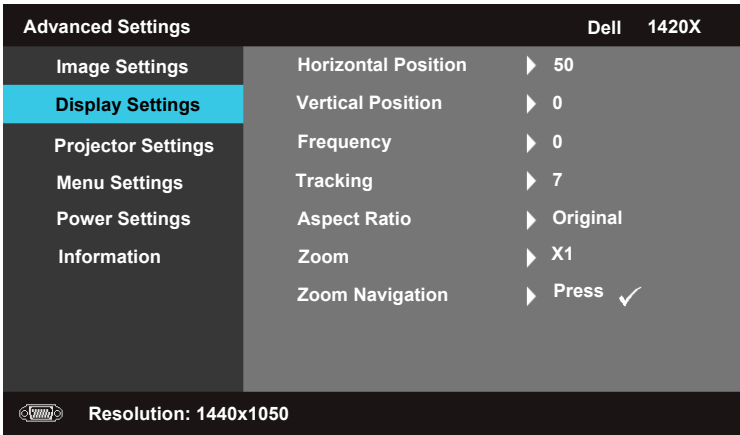

HORIZONTAL POSITION—Press to move the image to the left and to move the image to the right.

VERTICAL POSITION—Press to move the image down and to move the image up.

FREQUENCY—Allows you to change the display data clock frequency to match the frequency of your computer graphics card. If you see a vertical flickering wave, use Frequency control for coarse adjustment.

TRACKING—Synchronize the phase of the display signal with the graphic card. If you experience an unstable or flickering image, use **Tracking** to correct it. This is a fine adjustment.

ASPECT RATIO—Allows you to select the aspect ratio to adjust how the image appears.

- Original — Select Original to maintain the aspect ratio of image projected according to input source.
- 16:9 — The input source scales to fit the width of the screen to project a 16:9 screen image.
- 4:3 — The input source scales to fit the screen and projects a 4:3 image.



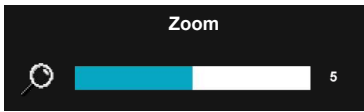

ZOOM—Press and to zoom the image.

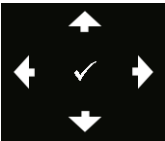

Adjust the image scale by pressing **Zoom+** or **Zoom-** on your remote control.



ZOOM NAVIGATION—Press  to activate Zoom Navigation menu.

Use     to navigate projection screen.

Display Settings (In Video Mode)

Select and press  to activate Display settings. The Display settings menu provides the following options:

Advanced Settings		Dell 1420X
Image Settings	Aspect Ratio	▶ Original
Display Settings	Zoom	▶ X1
Projector Settings	Zoom Navigation	▶ Press ✓
Menu Settings	3D Display	▶ Off
Power Settings	3D Sync Invert	▶ Off
Information		
 Resolution: 720x480		

ASPECT RATIO—Allows you to select the aspect ratio to adjust how the image appears.

- Original — Select Original to maintain the aspect ratio of image projected according to input source.
- 16:9 — The input source scales to fit the width of the screen to project a 16:9 screen image.
- 4:3 — The input source scales to fit the screen and projects a 4:3 image.



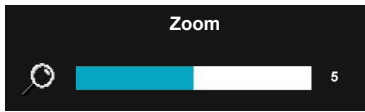

ZOOM—Press  and  to zoom the image.

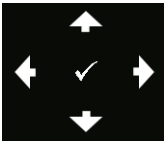

Adjust the image scale by pressing **Zoom+** or **Zoom-** on your remote control.



ZOOM NAVIGATION—Press  to activate Zoom Navigation menu.

Use     to navigate projection screen.

3D DISPLAY—Select On to start the 3D display function (default is Off).

 **NOTE:**

1 When you want to create a 3D experience, you will need a few other components including:

- Computer/Laptop with a 120 Hz signal output quad-buffered graphics card.
- "Active" 3D glasses with DLP Link.
- 3D content. See "Note 4".
- 3D Player. (Example: Stereoscopic Player..)

2 Enable the 3D function when it satisfies any of the below-mentioned conditions:

- Computer/Laptop with a graphics card, capable of outputting a 120 Hz signal via VGA cable.
- Input a suite of 3D content via Video and S-Video.

3 "3D Display" selection will only be enabled in the "Display Settings of the Advanced Settings" menu when the projector detects either of the inputs mentioned above.

4 3D support and refresh rate are as below:

- VGA 1280 x 720 120 Hz, 1024 x 768 120 Hz, and 800 x 600 120 Hz
- Composite/S-Video 60 Hz
- Component 480i

5 The recommended VGA signal for laptop is Single-mode output (Dual mode is not recommended).

3D SYNC INVERT—If you see a discrete or overlapping image while wearing DLP 3D goggles, you may need to execute 'Invert' to get best match of left/right image sequence to get the correct image. (For DLP 3D goggles)

Projector Settings

Select and press  to activate Projector settings. The Projector settings menu provides the following options:

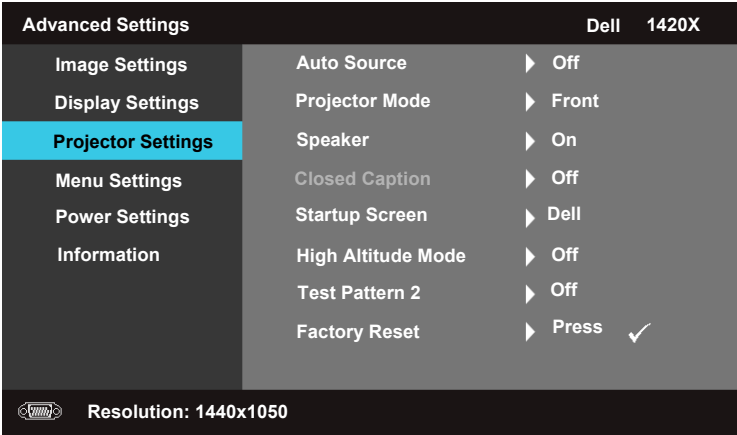

AUTO SOURCE—Select **Off** (the default) to lock the current input signal. If you press the Source button when the **Auto Source** mode is set to **Off**, you can manually select the input signal. Select **On** to auto detect the available input signals. If you press the Source button when the projector is on, it automatically finds the next available input signal.

PROJECTOR MODE—Allows you to select the projector mode, depending upon how the projector is mounted.

- Front — This is the default option.
- Front Ceiling — The projector turns the image upside down for ceiling-mounted projection.
- Rear — The projector reverses the image so that you can project from behind a translucent screen.
- Rear Ceiling — The projector reverses and turns the image upside down. You can project from behind a translucent screen with a ceiling-mounted projection.

SPEAKER —Select **On** to enable the speaker. Select **Off** to the disable speaker.

CLOSED CAPTION—Select **On** to enable close caption and activate the closed caption menu. Select appropriate closed caption options: CC1, CC2, CC3, and CC4.







NOTE: Closed Caption option is available for NTSC only.

STARTUP SCREEN—Default is Dell logo as wallpaper.

HIGH ALTITUDE MODE—Select **On** when your environment is between 1500 m and 3000 m.

TEST PATTERN 2—Test Pattern is used to test focus and resolution.

You can enable or disable the **Test Pattern 2** by selecting **Off**, **1** or **2**. You can also invoke the **Test Pattern 1** by pressing and holding down  and  buttons on the control panel simultaneously for 2 seconds. You can also invoke the test pattern 2 by pressing and holding down  and  buttons on the control panel simultaneously for 2 seconds.

Test Pattern 1:

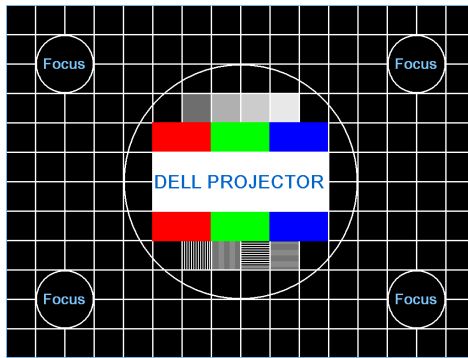

Test Pattern 2:

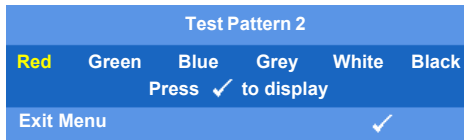

FACTORY RESET—Select and press  to reset all settings to its factory default, the warning message below appears.



Reset items include both computer sources and video source settings.

Menu Settings

Select and press  to activate menu settings. The menu settings consists of the following options:

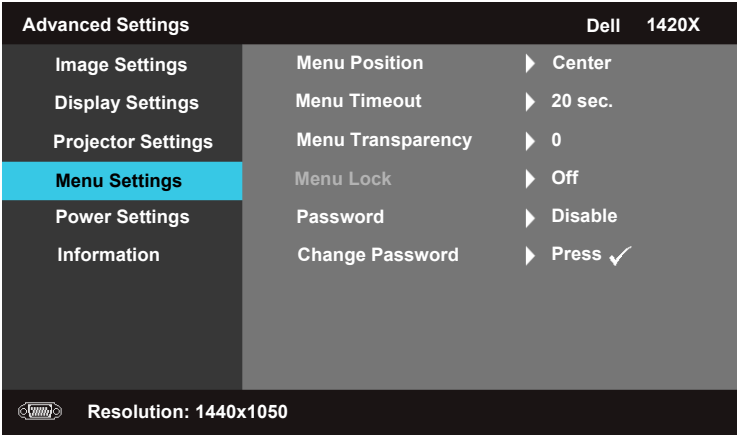

MENU POSITION—Allows you to change the position of the OSD menu on the screen.

MENU TIMEOUT—Allows you to adjust the time for an OSD timeout. By default, the OSD disappears after 20 seconds of non-activity.

MENU TRANSPARENCY—Select to change the transparency level of the OSD background.

MENU LOCK—Select **On** to enable Menu Lock and hide the OSD menu. Select **OFF** to disable the Menu Lock. If you want to disable the Menu Lock function and have the OSD appear, press the **Menu** button on the control panel or remote control for 15 seconds, then disable the function.

PASSWORD—When Password Protect is enabled, a Password Protect screen requesting you to enter a password will be displayed when the power plug is inserted into the electrical outlet and the power for the projector is first turned on. By default, this function is disabled. You can enable this feature, by selecting **Enabled**. If the password has been set before, key in the password first and select the function. This password security feature will be activated the next time you turn on the projector. If you enable this feature, you will be asked to enter the projector's password after you turn on the projector:

1 First time password input request:

- a Go to Menu Settings menu, press  and then select Password to Enable the password setting.

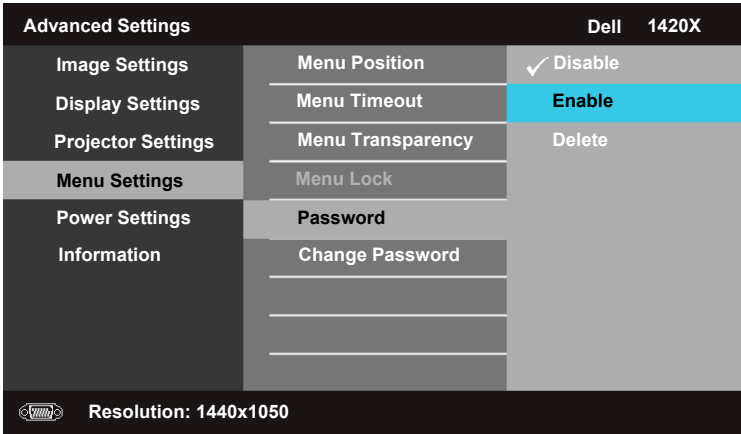

- b Enabling the Password function will pop up a character screen, key in a 4-digit number from the screen and press .



- c To confirm, enter the password again.
- d If the password verification is successful, you may resume with accessing the projector's functions and its utilities.
- 2 If you have entered an incorrect password, you will be given another 2 chances. After the three invalid attempts, the projector will automatically turn off.

 **NOTE:** If you forget your password, contact DELL™ or a qualified service personnel.

3 To disable the password function, select **Disable**.

4 To delete the password, select **Delete**.

CHANGE PASSWORD—Key in the original password, then enter the new password and confirm the new password again.

Please key in original password

Password (4 character code): XXXX

A	B	C	D	E	F	G	H	I	J
K	L	M	N	O	P	Q	R	S	T
U	V	W	X	Y	Z	0	1	2	3
4	5	6	7	8	9	←	Enter	Exit	

> < ✓ ^ Select

PPID CN-0R3KXG-S0081-137-0004 Confirm

Please key in new password

Password (4 character code): XXXX

A	B	C	D	E	F	G	H	I	J
K	L	M	N	O	P	Q	R	S	T
U	V	W	X	Y	Z	0	1	2	3
4	5	6	7	8	9	←	Enter	Exit	

> < ✓ ^ Select

PPID CN-0R3KXG-S0081-137-0004 Confirm

Please key in new password again

Password (4 character code): XXXX

A	B	C	D	E	F	G	H	I	J
K	L	M	N	O	P	Q	R	S	T
U	V	W	X	Y	Z	0	1	2	3
4	5	6	7	8	9	←	Enter	Exit	

> < ✓ ^ Select

PPID CN-0R3KXG-S0081-137-0004 Confirm

Power Settings

Select and press  to activate power settings. The power settings menu consists of the following options:

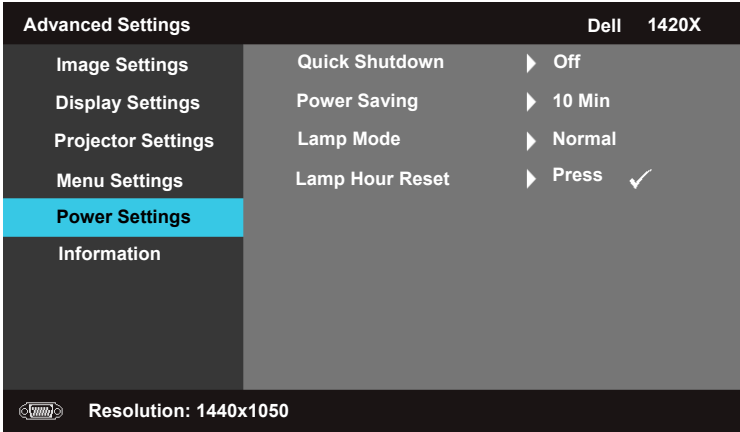

QUICK SHUTDOWN—Select **On** to turn off the projector with a single press of the **Power** button. This function allows the projector to quick power off with an accelerated fan speed. Slightly higher acoustic noise is expected during quick power off.



NOTE: Before you turn on the projector again, wait for 60 seconds to allow the internal temperature to stabilize. The projector will take a longer time to turn on if you try to power on immediately. Its cooling fan will run at full speed for about 30 seconds to stabilize the internal temperature.

POWER SAVING—Select **Off** to disable Power Saving mode. By default, the projector is set to enter power saving mode after 10 minutes of no activity. A warning message appears on screen showing a 60-second countdown before switching to power saving mode. Press any key buttons during countdown period to stop power saving mode.

You can also set a different delay period to enter power saving mode. The delay period is the time you want the projector to wait without an input signal. Power saving can be set to 30, 60, 90, or 120 minutes.

If an input signal is not detected during the delay period, the projector

turns off the lamp and goes into power saving mode. If an input signal is detected within the delay period, the projector automatically turns on. If an input signal is not detected within two hours during power saving mode, the projector switches from Power Saving mode to Power Off mode. To turn on the projector press the Power button.

LAMP MODE—Allows you to select between **Normal** or **ECO** mode.

Normal mode operates at full power level. **ECO** mode operates at a lower power level which may provide longer lamp life, quieter operation, and dimmer luminance output on the screen.

LAMP HOUR RESET—Press  and select the **Confirm** option to reset the lamp hour.

Information

The Information menu displays the current projector settings.

Advanced Settings		Dell 1420X
Image Settings	Model Name	: 1420X
Display Settings	Operating Hour	: 2 hours
Projector Settings	PPID	: CN-0R3KXG-S0081-137-0004
Menu Settings		
Power Settings		
Information		
 Resolution: 1440x1050		

Language

Allows you to set the language for the OSD. Press  to activate the **Language** menu.



Help

If you encounter problems with your projector, you can access the help menu for troubleshooting.

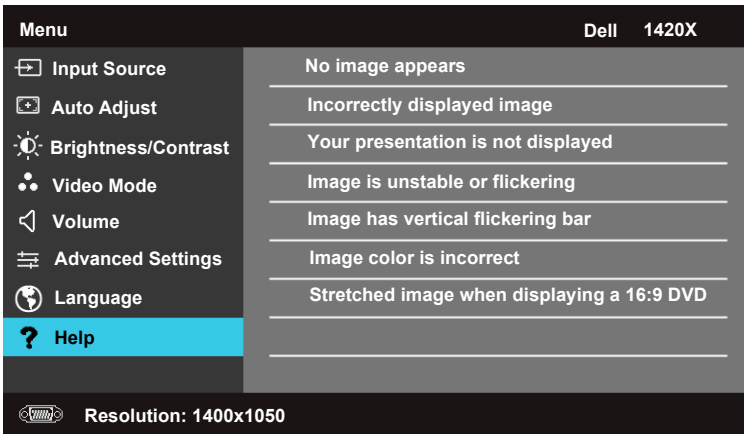

Troubleshooting Your Projector

If you experience problems with your projector, see the following troubleshooting tips. If the problem persists, contact Dell™ (see *Contacting Dell™* on page 57).

Problem

No image appears on the screen

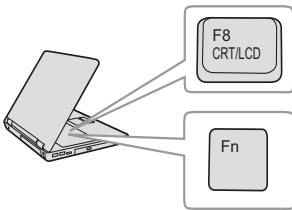





Possible Solution

- Ensure that the lens cap is removed and the projector is turned on.
- Ensure that the **Input Source** is set correctly in the OSD menu.
- Ensure the external graphics port is enabled. If you are using a Dell™ portable computer, press (Fn+F8). For other computers, see your respective documentation. The output signal from the computer is not according to industry standards. Should this happen, upgrade the video driver of the computer. For Dell computer, see support.dell.com.
- Ensure that all the cables are securely connected. See "Connecting Your Projector" on page 9.
- Ensure that the pins of the connectors are not bent or broken.
- Ensure that the lamp is securely installed (see "Changing the Lamp" on page 49).
- Use **Test Pattern** in the **Others** menu. Ensure that the colors of the test pattern are correct.

Missing Input Source.
Cannot switch to particular
Input Source.

Ensure that particular Input Source is set to
Enable.

Problem (continued)	Possible Solution (continued)
Partial, scrolling, or incorrectly displayed image	<ol style="list-style-type: none"> 1 Press the Auto Adjust button on the remote control or the control panel. 2 If you are using a Dell™ portable computer, set the resolution of the computer to XGA (1024 x 768): <ol style="list-style-type: none"> a Right-click the unused portion of your Microsoft® Windows® desktop, click Properties and then select Settings tab. b Verify that the setting is 1024 x 768 pixels for the external monitor port. c Press   (Fn+F8). <p>If you experience difficulty in changing resolutions or your monitor freezes, restart all the equipment and the projector.</p> <p>If you are not using a Dell™ portable computer, see your computer's documentation. The output signal from the computer may not be according to industry standards. Should this happen, upgrade the video driver of the computer. For a Dell computer, see support.dell.com.</p>
The screen does not display your presentation	If you are using a portable computer, press   (Fn+F8).
Image is unstable or flickering	Adjust the tracking in the OSD Display sub-menu (in PC Mode only).
Image has vertical flickering bar	Adjust the frequency in the OSD Display sub-menu (in PC Mode only).
Image color is incorrect	<ul style="list-style-type: none"> • If the display receives the wrong signal output from the graphics card, please set the signal type to RGB in the OSD Display tab. • Use Test Pattern in the Others menu. Ensure that the colors of the test pattern are correct.
Image is out of focus	<ol style="list-style-type: none"> 1 Adjust the focus ring on the projector lens. 2 Ensure that the projection screen is within the required distance from the projector (3.28 ft [1m] to 39.37 ft [12 m]).





Problem (continued)	Possible Solution (continued)
The image is stretched when displaying a 16:9 DVD	<p>The projector automatically detects the input signal format. It will maintain the aspect ratio of the projected image according to input signal format with an Original setting.</p> <p>If the image is still stretched, adjust the aspect ratio in the Set Up menu in the OSD.</p>
Image is reversed	Select Projector Settings from the OSD and adjust the projector mode.
Lamp is burned out or makes a popping sound	When the lamp reaches its end of life, it may burn out and may make a loud popping sound. If this occurs, the projector does not turn back on. To replace the lamp, see "Changing the Lamp" on page 49.
LAMP light is solid amber	If the LAMP light is solid amber, replace the lamp.
LAMP light is blinking amber	<p>If the LAMP light is blinking amber, Lamp module connection may be disrupted. Please check the lamp module and ensure that it is properly installed.</p> <p>If the LAMP light and the Power light are blinking amber, the lamp driver has failed and the projector will automatically shut down.</p> <p>If the LAMP and TEMP light are blinking amber and the Power light is solid blue, the color wheel has failed and the projector will automatically shut down.</p> <p>To clear the protection mode, press and hold the POWER button for 10 seconds.</p>
TEMP light is solid amber	The projector has overheated. The display automatically shuts down. Turn the display on again after the projector cools down. If the problem persists, contact Dell™.

Problem (continued)	Possible Solution (continued)
TEMP light is blinking amber	A projector fan has failed and the projector will automatically shut down. Try to clear the projector protection mode by pressing and holding the POWER button for 15 seconds. Please wait for about 5 minutes and try to power up again. If the problem persists, contact Dell™.
The OSD does not appear on the screen	Try to press the Menu button on the panel for 15 seconds to unlock the OSD. Check the Menu Lock on page 38.
The remote control is not operating smoothly or works only within a limited range	The battery may be low. If so, replace with the same or equivalent type recommended by the battery manufacturer.

Guiding Signals

Projector Status	Description	Control Buttons		Indicator	
		Power	Menu	TEMP (Amber)	LAMP (Amber)
Standby mode	Projector in Standby mode. Ready to power on.	BLUE Flashing	OFF	OFF	OFF
Warming up mode	Projector takes some time to warm up and power on.	BLUE	BLUE	OFF	OFF
Lamp on	Projector in Normal mode, ready to display an image. <input checked="" type="checkbox"/> Note: The OSD menu is not accessed.	BLUE	BLUE	OFF	OFF
Cooling mode	Projector is cooling to shutdown.	BLUE	OFF	OFF	OFF
Power Saving mode	Power Saving mode has been activated. The projector will automatically enter standby mode, if an input signal is not detected in two hours.	AMBER Flashing	OFF	OFF	OFF
Cooling before Power Saving mode	The projector takes 60 seconds to cool down before entering Power Saving mode.	AMBER	OFF	OFF	OFF
Projector overheated	Air vents might be blocked or ambient temperature may be above 35°C. The projector automatically shuts down. Ensure that the air vents are not blocked and that the ambient temperature is within operational range. If the problem persists, contact Dell.	OFF	OFF	AMBER	OFF
Lamp driver overheated	The lamp driver is overheated. The air vents may be blocked. The projector automatically shuts down. Turn the display on again after the projector cools down. If the problem persists, contact Dell.	AMBER	OFF	AMBER	OFF
Fan breakdown	One of the fans has failed. The projector automatically shuts down. If the problem persists, contact Dell.	OFF	OFF	AMBER Flashing	OFF
Lamp driver breakdown	The lamp driver has failed. The projector automatically shuts down. Unplug the power cord after three minutes then turn the display on again. If this problem persists, contact Dell.	AMBER Flashing	OFF	OFF	AMBER Flashing
Lamp module connection failed	Lamp module connection may be disrupted. Please check the lamp module and ensure that it is properly installed. If the problem persists, contact Dell.	OFF	OFF	OFF	AMBER Flashing
Color Wheel breakdown	Color wheel cannot start. The projector has failed and the projector automatically shuts down. Unplug the power cord after three minutes and then turn on the projector. If this problem persists, contact Dell.	BLUE	OFF	AMBER Flashing	AMBER Flashing
Lamp failure	Lamp defective. Replace the lamp. Lamp is reaching its end of usable life.	OFF	OFF	OFF	AMBER
OSD on	When the projector's OSD is called up and is visible to users.	BLUE	BLUE	OFF	OFF

Changing the Lamp

-  **WARNING:** Before you begin any of the procedures in this section, follow the Safety Instructions as described on page 7.
-  **WARNING:** Use an original lamp to ensure safe and optimal working condition of your projector.
-  **WARNING:** The lamp becomes very hot when in use. Do not attempt to replace the lamp until the projector has been allowed to cool down for at least 30 minutes.
-  **WARNING:** Do not touch the bulb or the lamp glass at any time. Projector lamps are very fragile and may shatter if touched. The shattered glass pieces are sharp and can cause injury.
-  **WARNING:** If the lamp shatters, remove all broken pieces from the projector and dispose or recycle according to state, local, or federal law. For more information see www.dell.com/hg.

- 1 Turn off the projector and disconnect the power cord.
- 2 Let the projector cool for at least 30 minutes.
- 3 Loosen the screws that secure the lamp cover, and remove the cover.
- 4 Loosen the screw that secures the lamp.
- 5 Pull the lamp up by its metal handle.

 **NOTE:** Dell™ may require lamps replaced under warranty to be returned to Dell™. Otherwise, contact your local waste disposal agency for the address of the nearest deposit site.

- 6 Replace with the new lamp.
- 7 Tighten the screw that secures the lamp.
- 8 Replace the lamp cover and tighten the two screws.
- 9 Reset the lamp usage time by selecting "Confirm" for **Lamp Hour Reset** in the **Power Settings** (see "Power Settings" on page 41). When a new lamp module has been changed, the projector will automatically detect and reset the lamp hours.

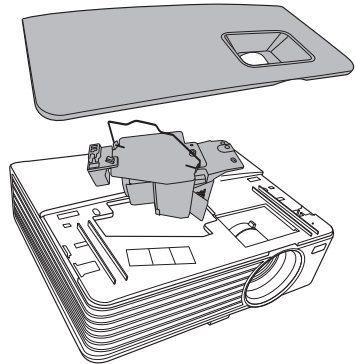



WARNING: Lamp Disposal (for the US only)



LAMP(S) INSIDE THIS PRODUCT CONTAIN MERCURY AND MUST BE RECYCLED OR DISPOSED OF ACCORDING TO LOCAL, STATE OR FEDERAL LAWS. FOR MORE INFORMATION, GO TO WWW.DELL.COM/HG OR CONTACT THE ELECTRONIC INDUSTRIES ALLIANCE AT WWW.EIAE.ORG. FOR LAMP SPECIFIC DISPOSAL INFORMATION CHECK WWW.LAMPRECYCLE.ORG.

Specifications

Light Valve	0.55" XGA S450 DMD, DarkChip3™
Brightness	1420X: 2700 ANSI Lumens (Max.) 1430X: 3200 ANSI Lumens (Max.)
Contrast Ratio	2400:1 Minimum (Full On/Full Off)
Uniformity	85% Typical (Japan Standard - JBMA)
Native Resolution	1024 x 768 (XGA) 4:3 Aspect Ratio
Displayable Color	1.07 billion colors
Color Wheel Speed	2X
Projection Lens	F-Stop: F/ 2.54~2.73 Focal length, f=18.18~21.84 mm 1.2X manual Zoom Lens Throw ratio =1.64~1.97 wide and tele 110% offset
Projection Screen Size	38-180 inches (diagonal)
Projection Distance	3.28~26.24 ft (1 m ~ 8 m)
Video Compatibility	Composite Video / S-Video: NTSC (M, 3.58, 4.43), PAL (B, D, G, H, I, M, N, 4.43), SECAM (B, D, G, K, K1, L, 4.25/4.4)) Component Video via VGA: 1080i/p, 720p, 576i/p, 480i/p
Power Supply	Universal AC90-264 50/60 Hz with PFC input

Power Consumption

1420X:

Normal mode: 305W \pm 10% @ 110Vac

Eco mode: 265W \pm 10% @ 110Vac

Standby mode: <0.5W

1430X:

Normal mode: 368W \pm 10% @ 110Vac

Eco mode: 305W \pm 10% @ 110Vac

Standby mode: <0.5W

Audio

1 speaker x 2 watt RMS

Noise Level

1420X:

33 dB(A) Normal mode, 29 dB(A) Eco mode

1430X:

36 dB(A) Normal mode, 32 dB(A) Eco mode

Weight

5.7 lbs (2.6 kg)

Dimensions (W x H x D)

11.4 x 3.6 x 9.3 inches (290 x 90.82 x 238 mm)

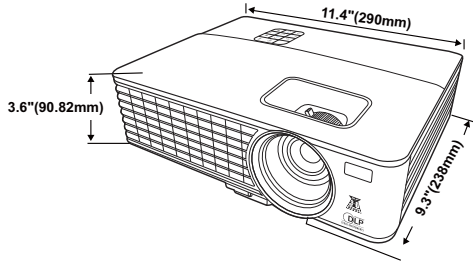

Environmental

Operating temperature: 0 °C - 35 °C (32 °F- 95 °F)

Humidity: 90% maximum

Storage temperature: -30 °C to 65 °C (-22 °F to 149 °F)

Humidity: 90% maximum

Shipping temperature: -20 °C to 60 °C (-4 °F to 140 °F)

Humidity: 90% maximum

I/O Connectors

Power: One AC power socket (3-pins - C14 inlet)

VGA input: Two 15-pin D-sub connectors (Blue), VGA-A & VGA-B, for analog RGB/Component input signals.

Lamp

VGA output: One 15-pin D-sub connector (Black) for VGA-A loop through.

S-Video input: One standard 4-pin min-DIN S-Video connector for Y/C signal.

Composite video input: One Yellow RCA jack for CVBS signal.

Analog Audio input: One 3.5mm stereo mini phone jack (Green).

Fix audio output: One 3.5mm stereo mini phone jack (Blue).

Mini USB (type B) port: One mini USB slave for remote support.

RS232 port: One 9-pin D-sub connector

1420X:

Osram 190W user-replaceable lamp (up to 4,500 hours in Normal Mode / up to 6,000 hours in Eco-Mode)

1430X:

Osram 240W user-replaceable lamp (up to 3,000 hours in Normal Mode / up to 5,000 hours in Eco-Mode)



NOTE: The lamp life rating for any projector is a measure of brightness degradation only, and is not a specification for the time it takes a lamp to fail and cease light output. Lamp life is defined as the time it takes for more than 50 percent of a lamp sample population to have brightness decrease by approximately 50 percent of the rated lumens for the specified lamp. The lamp life rating is not guaranteed in any way. The actual operating life span of a projector lamp will vary according to operating conditions and usage patterns. Usage of a projector in stressful conditions which may include dusty environments, under high temperatures, many hours per day and abrupt powering-off will most likely result in a lamp's shortened operating life span or possible lamp failure.

Compatibility Modes (Analog/Digital)

Resolution	Mode	Refresh rate (Hz)	H-frequency (kHz)	Clock (MHz)
720 x 400	720x400_70	70.087	31.469	28.3221
640 x 480	VGA_60	59.94	31.469	25.175
	VGA_72	72.809	37.861	31.5
	VGA_75	75	37.5	31.5
	VGA_85	85.008	43.269	36
800 x 600	SVGA_56	56.25	35.156	36
	SVGA_60	60.317	37.879	40
	SVGA_72	72.188	48.077	50
	SVGA_75	75	46.875	49.5
	SVGA_85	85.061	53.674	56.25
	SVGA_120* (Reduce Blanking)	119.854	77.425	83
1024 x 768	XGA_60	60.004	48.363	65
	XGA_70	70.069	56.476	75
	XGA_75	75.029	60.023	78.75
	XGA_85	84.997	68.667	94.5
	XGA_120* (Reduce Blanking)	119.989	97.551	115.5
1152 x 864	1152 x 864_75	75	67.5	108
1024 x 576		60	35.82	46.966
1024 x 600		64.995	41.467	51.419
1280 x 768	1280 x 768_60	59.87	47.776	79.5

1280 x 800	WXGA_60	59.81	49.702	83.5
	WXGA_75	74.934	62.795	106.5
	WXGA_85	84.88	71.554	122.5
	WXGA_120* (Reduce Blanking)	119.909	101.563	146.25
1280 x 1024	SXGA_60	60.02	63.981	108
	SXGA_75	75.025	79.976	135
	SXGA_85	85.024	91.146	157.5
1280 x 960	1280 x 960_60	60	60	108
	1280 x 960_85	85.002	85.938	148.5
1366 x 768	1366 x 768_60	59.79	47.712	85.5
1440 x 900	WXGA+_60	59.887	55.935	106.5
1400 x 1050	SXGA+_60	59.978	65.317	121.75
1600 x 1200	UXGA	60	75	162
1680 x 1050	1680x1050_60	59.954	65.29	146.25
640 x 480@67Hz	MAC13	66.667	35	30.24
832 x 624@75Hz	MAC16	74.546	49.722	57.28
1024 x 768@75Hz	MAC19	74.93	60.241	80
1152 x 870@75Hz	MAC21	75.06	68.68	100

NOTE: * supported timings for 3D signal with frame sequential format.

Compatibility Modes (YPbPr)

Resolution	Mode	Refresh rate (Hz)	H-frequency (kHz)	Clock (MHz)
720 x 480	480i	59.94	15.73	13.5
720 x 480	480p	59.94	31.47	27
720 x 576	576i	50	15.63	13.5
720 x 576	576p	50	31.25	27
1280 x 720	720/50p	50	37.5	74.25
1280 x 720	720/60p	60	45	74.25

1920 x 1080	1080/24P	24	27	74.25
1920 x 1080	1080/25P	25	28.13	74.25
1920 x 1080	1080/30P	30	33.75	74.25
1920 x 1080	1080/50i	50	28.13	74.25
1920 x 1080	1080/60i	60	33.75	74.25
1920 x 1080	1080/50P	50	56.25	148.5
1920 x 1080	1080/60P	60	67.5	148.5

Compatibility Modes (Video/S-Video)

Video mode	fh(kHz)	fv(Hz)	fsc(MHz)
NTSC	15.73	60	3.58
PAL	15.63	50	4.43
SECAM	15.63	50	4.25 or 4.41
PAL-M	15.73	60	3.58
PAL-N	15.63	50	3.58
PAL-60	15.73	60	4.43
NTSC4.43	15.73	60	4.43

Contacting Dell

For customers in the United States, call 800-WWW-DELL (800-999-3355).



NOTE: If you do not have an active Internet connection, you can find contact information on your purchase invoice, packing slip, bill, or Dell product catalog.

Dell™ provides several online and telephone-based support and service options. Availability varies by country and product, and some services may not be available in your area. To contact Dell for sales, technical support, or customer service issues:

- 1 Visit support.dell.com.
- 2 Verify your country or region in the **Choose A Country/Region** drop-down menu at the bottom of the page.
- 3 Click **Contact Us** on the left side of the page.
- 4 Select the appropriate service or support link based on your need.
- 5 Choose the method of contacting Dell that is convenient for you.

Appendix: Glossary

ANSI LUMENS — A standard for measuring the brightness. It is calculated by dividing a square meter image into nine equal rectangles, measuring the lux (or brightness) reading at the center of each rectangle, and averaging these nine points.

ASPECT RATIO — The most popular aspect ratio is 4:3 (4 by 3). Early television and computer video formats are in a 4:3 aspect ratio, which means that the width of the image is 4/3 times the height.

Brightness — The amount of light emitted from a display or projection display or projection device. The brightness of projector is measured by ANSI lumens.

Color Temperature — The color appearance of white light. Low color temperature implies warmer (more yellow/red) light while high color temperature implies a colder (more blue) light. The standard unit for color temperature is Kelvin (K).

Component Video — A method of delivering quality video in a format that consists of the luminance signal and two separate chrominance signals and are defined as Y'Pb'Pr' for analog component and Y'Cb'Cr' for digital component. Component video is available on DVD players.

Composite Video — A video signal that combines the luma (brightness), chroma (color), burst (color reference), and sync (horizontal and vertical synchronizing signals) into a signal waveform carried on a single wire pair. There are three kind of formats, namely, NTSC, PAL and SECAM.

Compressed Resolution — If the input images are of higher resolution than the native resolution of the projector, the resulting image will be scaled to fit the native resolution of the projector. The nature of compression in a digital device means that some image content is lost.

Contrast Ratio — Range of light and dark values in a picture, or the ratio between their maximum and minimum values. There are two methods used by the projection industry to measure the ratio:

- 1 *Full On/Off* — measures the ratio of the light output of an all white image (full on) and the light output of an all black (full off) image.

2 ANSI — measures a pattern of 16 alternating black and white rectangles. The average light output from the white rectangles is divided by the average light output of the black rectangles to determine the ANSI contrast ratio.

Full On/Off contrast is always a larger number than ANSI contrast for the same projector.

dB — decibel — A unit used to express relative difference in power or intensity, usually between two acoustic or electric signals, equal to ten times the common logarithm of the ratio of the two levels.

Diagonal Screen — A method of measuring the size of a screen or a projected image. It measures from one corner to the opposite corner. A 9FT high, 12FT wide, screen has a diagonal of 15FT. This document assumes that the diagonal dimensions are for the traditional 4:3 ratio of a computer image as per the example above.

DLP® — Digital Light Processing™ — Reflective display technology developed by Texas Instruments, using small manipulated mirrors. Light passes through a color filter is sent to the DLP mirrors which arrange the RGB colors into a picture projected onto screen, also known as DMD.

DMD — Digital Micro-Mirror Device — Each DMD consists of thousands of tilting, microscopic aluminum alloy mirrors mounted on a hidden yoke.

Focal Length — The distance from the surface of a lens to its focal point.

Frequency — It is the rate of repetition in cycles per seconds of electrical signals. Measured in Hz (Hertz).

Hz (Hertz) — Unit of frequency.

Keystone Correction — Device that will correct an image of the distortion (usually a wide-top narrow-bottom effect) of a projected image caused by improper projector to screen angle.

Maximum Distance — The distance from a screen the projector can be to cast an image that is usable (bright enough) in a fully darkened room.

Maximum Image Size — The largest image a projector can throw in a darkened room. This is usually limited by focal range of the optics.

Minimum Distance — The closest position that a projector can focus an image onto a screen.

NTSC — National Television Standards Committee. North American standard for video and broadcasting, with a video format of 525 lines at 30 frames per second.

PAL — Phase Alternating Line. A European broadcast standard for video and broadcasting, with a video format of 625 lines at 25 frames per second.

Reverse Image — Feature that allows you to flip the image horizontally. When

used in a normal forward projection environment text, graphics, etc. are backwards. Reverse image is used for rear projection.

RGB — Red, Green, Blue — typically used to describe a monitor that requires separate signals for each of the three colors.

S-Video — A video transmission standard that uses a 4-pin mini-DIN connector to send video information on two signal wires called luminance (brightness, Y) and chrominance (color, C). S-Video is also referred to as Y/C.

SECAM — A French and international broadcast standard for video and broadcasting, closely related to PAL but with a different method of sending color information.

SSID — Service Set Identifiers — A name used to identify the particular wireless LAN to which a user wants to connect.

SVGA — Super Video Graphics Array — 800 x 600 pixels count.

SXGA — Super Extended Graphics Array, — 1280 x 1024 pixels count.

UXGA — Ultra Extended Graphics Array — 1600 x 1200 pixels count.

VGA — Video Graphics Array — 640 x 480 pixels count.

XGA — Extended Video Graphics Array — 1024 x 768 pixels count.

Zoom Lens — Lens with a variable focal length that allows operator to move the view in or out making the image smaller or larger.

Zoom Lens Ratio — Is the ratio between the smallest and largest image a lens can project from a fixed distance. For example, a 1.4:1 zoom lens ratio means that a 10 foot image without zoom would be a 14 foot image with full zoom.

Index

A

- Adjusting the Projected Image 16
 - Adjusting the Projector Height 16
 - lower the projector
 - Elevator button 16
 - Elevator foot 16
- Adjusting the Projector Zoom and Focus 17
 - Focus ring 17
 - Zoom tab 17

C

- Changing the Lamp 49
- Connecting the Projector
 - Composite video cable 13
 - Connecting with a Component Cable 14
 - Connecting with a Composite Cable 13
 - Connecting with an S-video Cable 12
 - Power cord 10, 11, 12, 13, 14
 - S-video cable 12
 - To Computer 10
 - USB to USB cable 10
 - VGA to VGA cable 10, 11
 - VGA to YPbPr cable 14

Connection Ports

- Audio output connector 9

- Composite video connector 9
- Mini USB-B remote connector 9
- Power cord connector 9
- S-video connector 9
- VGA-A input (D-sub) connector 9
- VGA-A output (monitor loop-through) 9
- VGA-B input (D-sub) connector 9

Contact Dell 6, 46, 49

Control Panel 20

D

- Dell
 - contacting 57

M

- Main Unit 7
 - Control panel 7
 - Focus ring 7
 - IR receiver 7
 - Lens 7
 - Zoom tab 7
- Menu Timeout 38
- Menu Transparency 38

O

- On-Screen Display 26
 - Main Menu 26

P

- phone numbers 57
- Power Saving 41
- Powering On/Off the Projector
 - Powering Off the Projector 15
 - Powering On the Projector 15

Q

- Quick Shutdown 41

R

- Remote Control 22
 - IR receiver 20
- Reset, Factory 37
- RS232 control port 9

S

- Security Settings 42
- Specifications
 - Audio 52
 - Brightness 51
 - Color Wheel Speed 51
 - Contrast Ratio 51
 - Dimensions 52
 - Displayable Color 51
 - Environmental 52

- I/O Connectors 52
- Light Valve 51
- Noise Level 52
- Power Consumption 52
- Power Supply 51
- Projection Distance 51
- Projection Lens 51
- Projection Screen Size 51
- Uniformity 51
- Video Compatibility 51
- Weight 52

- support
 - contacting Dell 57

T

- telephone numbers 57
- Troubleshooting 44
 - Contact Dell 44

